

Jadever Scale Co., Ltd.
Xiamen Jadever Scale Co., Ltd.



Discipline | Honesty | Knowledge | Innovation

JADEVER[®]
since 1986



JC
Crane Scale



Bench Scale
Iron/Stainless Steel



JWN
Weighing Scale



JWP
Waterproof Scale



SKY-W
Precision Balance

HOT SALE

JC Crane Scale/Bench Scale Iron&Stainless Steel/JWN Weighing Scale
JWP Waterproof Scale/SKY-W Precision Balance

Contents

- 02 Portable Scale
- 05 Precision Balance
- 08 Counting Scale
- 11 Weighing Scale
- 14 Price Computing Scale
- 16 Waterproof Scale
- 17 Industrial Indicator
- 25 Bench Scale
- 27 Floor Scale
- 28 Crane Scale
- 31 Accessories
- 32 External Connection Modules

JKD pocket scale

- 1/5,000 resolution
- Light weight, easy to carry, just put at your waist, portable scale
- Bright LCD display with green backlight
- Strain gage Load Cell
- Stainless steel weighing pan
- Overload and transport protection device
- Zero/ Tare/ Net Weight/ Gross Weight/ Simple Counting functions
- Auto shut off for power saving
- Ideal for applications including laboratory, jewelry, gold, silver, dental, herbs or any other use



Model	JKD-250	JKD-500	JKD-1000
Capacity(g)	250	500	1000
Division(g)	0.05	0.1	0.2
Weighing units	g / oz / ct / pcs		
Display	5 digits, 14mm digit height, LCD display with green backlight		
Weighing pan(mm)	65x75(stainless steel)		
Scale dimension(mm)	135x80x24		
Weight	Net Weight: 120g, Gross Weight: 140g		
Power supply	3*AAA dry batteries		

JKH portable scale

- 1/5,000 resolution
- Compact size, easy to carry
- Bright LCD with green backlight
- Removable stainless steel weighing pan
- Anti-Cockroach and transport protection devices
- Zero/ Tare/ Weighing/ Net Weight/ Gross Weight/ Simple counting functions
- Auto shut off for power saving
- Ideal for applications including laboratory, herbs, food processing, hardware evaluation or any other use



Model	JKH-500	JKH-1000	JKH-2000	JKH-4000
Capacity(g)	500	1000	2000	4000
Division(g)	0.1	0.2	0.5	1
Weighing units	g / oz / ct / pcs; kg / g / lb / pcs			
Display	5 digits, 14mm digit height, LCD display with green backlight			
Weighing pan(mm)	140x140 (stainless steel)			
Scale dimension(mm)	170x200x45			
Weight	Net Weight: 730g, Gross Weight: 1170g			
Power supply	4*AA dry batteries or adaptor			

JK-02 digital kitchen scale

- High precision Load Cell
- Complete stainless steel structure
- Runs on carbon-zinc dry batteries
- Functions: Tare, Auto power off, multiple units selections, etc
- Weighing is quick and stable
- Overload protection for better delivery condition
- Application: food, coarse grains, medicinal material, etc



Model	JK-02		
Capacity(g)	1000	3000	6000
Division(g)	0.1	0.5	1
Power supply	2×AA dry batteries		
Pan size(mm)	∅=140 (S.S. Pan cover)		
Bowl size(mm)	∅=210 (S.S. Bowl)		
Appearance size(mm)	230×178×50		
Material	stainless steel		

JH-02 bathroom scale

- Simply tap scale to activate it
- Tempered glass platform
- Units convertible in kg/ lb
- Overload/ Low battery indication
- Auto zero function
- Low power consumption and auto shut off for power saving
- More colors available
- Ideal for applications including household, bathroom, hospital, hotel or any other use



Model	JH-02	
Capacity (kg/lb)	150 kg	330 lb
Division (g/lb)	100 g	0.2 lb
Display	LCD display	
Scale dimension(mm)	300x300x20	
Weight	Net weight: 1.68kg, Gross weight: 1.92kg	
Power supply	2*AAA dry batteries	
Operating temp.	10°C~40°C	

JMH/JMH-02 mini-hanging scale

- Easy to carry and simple operation
- Bright LCD display with blue backlight
- Tare/ Zero tracking/ Unit change functions
- Locking function
- Auto shut off for power saving
- Ideal for applications including family-run shops, household, vendors, food service, commercial needs or any other use



Model	JMH			JMh-02	
Capacity (kg)	10	20	40	0-10	10-50
Division (g)	5	10	20	5	10
Weighing units	kg/lb/oz				
Display	4 digits, 11mm digit height, LCD display				
Scale dimension(mm)	150×72×24			125×59×24	
Weight	N.W:127g,G.W:162g			N.W:181g,G.W:190g	
Power supply	2*AAA dry batteries				

Luggage scale

- Easy operation
- Unit kg/ lb/ oz/ N/ °C
- Temperature display
- Auto power saving function
- Easy to read 1.5" LCD display
- Tare and Zero function
- Ideal for applications including family-run shops, household, vendors, food service, commercial needs or any other use



Model	Luggage
Capacity(kg)	44kg/110lb
Division(g)	20
Weighing units	kg / lb /oz / N / °C
Display	11mm digit height, 1.5" LCD display
Strap length (mm)	200
Dimension(mm)	155X60X25
Weight	Net weight 170g; Gross weight 205g
Power supply	2*AAA dry batteries

SKY-C precision counting balance

- High resolution in 1/30,000, professional counting balance
- Battery and adaptor in dual mode to avoid power instability
- ACAI function ensures more quick and accurate count
- Zero range setting and filter setting for counting under various condition
- LCD display with green backlight
- Upper/lower limit quantity check function
- Accumulation, Accumulation display and Accumulation clear function
- Auto printing within OK range
- RS-232 as a standard
- Relay/RTC/U-KEY connector/Wifi/Ethernet(Optional)



Model	SKY-C-300	SKY-C-600	SKY-C-1500	SKY-C-3000
Capacity (g)	300	600	1500	3000
Division (g)	0.01	0.02/0.01	0.05	0.1
Weighing units	kg kg, kg g, g g, lb lb			
Display	LCD display			
Weighing pan (mm)	145*125mm			
Dimension (mm)	238*175*75mm			
Weight	980g			
Power supply	DC adaptor(9V/400mA) / Rechargeable battery(6V/1.3Ah)			

SKY-W precision balance

- High resolution in 1/30,000
- Battery and adaptor in dual mode to avoid power instability
- Zero range setting and filter setting for weighing under various condition
- LCD display with green backlight
- Upper/lower limit weighing alarming function
- Accumulation, Accumulation display and Accumulation clear function
- Auto printing within OK range
- RS-232 as a standard
- Relay/RTC/U-KEY connector/Wifi/Ethernet(Optional)
- Ideal for applications including laboratory, school, jewelry, gold, silver, herbs, quality control or any other use



Model	SKY-W-300	SKY-W-600	SKY-W-1500	SKY-W-3000
Capacity (g)	300	600	1500	3000
Division (g)	0.01	0.02/0.01	0.05	0.1
Weighing units	kg, g, ct, lb, oz, GN, pcs			
Display	LCD display			
Weighing pan (mm)	145*125mm			
Dimension (mm)	238*175*75mm			
Weight	980g			
Power supply	DC adaptor(9V/400mA) / Rechargeable battery(6V/1.3Ah)			

SNUGIII precision balance

- High resolution in 1/30,000&1/60,000
- Bright LCD with green backlight
- Wind shield device for a better weighing result
- Overload and transport protection devices
- Zero/ Tare/ Weighing/ Piece Count/ Sampling/ Percentage Weighing/ RTC functions
- Auto shut off for power saving
- Auto printing within OK range
- RS-232 (as a standard)
- Blue Tooth/U-KEY connector/WP wireless print/Wifi/Ethernet(optional)
- Ideal for applications including laboratory, school, jewelry, gold, silver, herbs, quality control or any other use



- ★ A/D 5530
- ★ 1/120000 resolution
- ★ HBM load cell



Model	SNUGIII -150	SNUGIII -300	SNUGIII -600	SNUGIII -1200	SNUGIII -1500	SNUGIII -3000
Capacity (g)	150	300	600	1200	1500	3000
Division (g)	0.005	0.01/0.005	0.01/0.02	0.01	0.05	0.1/0.05
Weighing units	kg, g, ct, lb, oz, dr, GN, ozt, dwt, MM, tl, T, tl.J, tl.H, t, pcs					
Display	6 digits, 14mm digit height, LCD display with green backlight					
Weighing pan (mm)	Φ125	146×125 (stainless steel)				
Scale dimension (mm)	220×180×182					
Weight	Net weight: 1.15kg, Gross weight: 1.85kg					
Power supply	4*C dry batteries or adaptor					

JBS-10mg high precision balance

- Adopts gold-plated ceramic variable capacitance sensor
- LCD screen, bright and clear
- Streamline design, high strength, anti-leakage, antistatic property and corrosion resistance
- Highly sensitive temperature sensor enables to minimize effect of temperature on operation
- Highly sensitive moisture sensor enables to minimize effect of moisture on operation
- Standard RS232 communication interface realizes data communication between balance and PC, printer and other devices
- Multiple weighing unit conversion: g, ct, oz etc
- Built-in multiple weighing program and application: counting function, upper and lower limit of weight checking function, cumulative weighing function and percentage weighing function



Model	JBS-12002	JBS-22002	JBS-32002	JBS-42002	JBS-52002	JBS-62002
Max. Capacity(g)	1200	2200	3200	4200	5200	6200
Readability	0.01g					
Repeatability(≤g)	±0.01g					
Linearity error(≤g)	±0.01g					
Temperature	13-25℃					
Moisture	10%-70% RH					
Response time (Average value)	2.5 sec					
Accuracy grade	II Grade					
Pan size	Φ 160mm					
Dimension	230*310*90mm					
Preheat time	20-30 min.					
DC Adaptor	Input: 220V AC/50HZ; Output: 7.5V DC/600mA					
Baud rate options	300, 600, 1200, 2400, 4800, 9600					

JBS-1mg laboratory high precision balance

- Adopts gold-plated ceramic variable capacitance sensor
- LCD screen, bright and clear
- Streamline design, high strength, anti-leakage, antistatic property and corrosion resistance
- Highly sensitive temperature sensor enables to minimize effect of temperature on operation
- Highly sensitive moisture sensor enables to minimize effect of moisture on operation
- Standard RS232 communication interface realizes data communication between balance and PC, printer and other devices
- Multiple weighing unit conversion: g、ct、oz etc
- Built-in multiple weighing program and application: counting function, upper and lower limit of weight checking function, cumulative weighing function and percentage weighing function



Model	JBS-1203	JBS-2203	JBS-3203	JBS-4203	JBS-5203	JBS-6203
Max. Capacity(g)	120g	220g	320g	420g	520g	620g
Readability	0.001g					
Repeatability(≤g)	±0.001g					
Linearity error(≤g)	±0.001g					
Temperature	13-25℃					
Moisture	10%-70% RH					
Response time (Average value)	2.5 sec.					
Accuracy grade	II Grade					
Pan size	φ 115mm					
Dimension	230*310*330mm					
Preheat time	20-30 min.					
DC Adaptor	Input: 220V AC/50HZ; Output: 7.5V DC/600mA					
Baud rate options	300、600、1200、2400、4800、9600					

JBS-S 0.1mg laboratory high precision balance

- Adopts underneath type electromagnetic force sensor
- All transparent glass draft shield, samples can be seen entirely and clearly
- Standard RS232 communication port, realize the communication with computer, printer or other devices
- Detachable LCD display, protect the balance from shock and vibration when user operates the balance
- Basic weighing, counting weighing, percent weighing and other weighing mode
- Optional functions/accessories: below hook weighing device, thermal printer, density kit
- Ideal for applications including scientific research, education, medical treatment, metallurgy, agriculture or any other use



Model	JBS-S 1204	JBS-S 2204	JBS-S 1204C	JBS-S 2204C
Max. Capacity(g)	120g	220g	120g	220g
Readability	0.0001g			
Repeatability(≤g)	±0.0002g			
Linearity error(≤g)	±0.0002g			
Calibration method	External weight calibration		Automatic internal calibration	
Net weight	3.5kg			
Stabilization time	2.5s.			
Warm-up Time	30-60 minutes			
Pan size	φ 90mm			
Permissible ambient Condition	+10℃ to +30℃			
Humidity of Air	20 – 80% Relative (Not condensing)			
Power Supply	AC230V, 50-60hZ			
Interface	RS232/RS485			
Weighing Mode	Basic weighing, counting weighing, percent weighing			

JCQ counting scale



- 1/15000 resolution (free setting capacity and division)
- Single point and linear calibration available
- Unit weight memory up to 20 pieces
- ACAI function results in a more accurate count by increasing the reference weight
- Zero range setting and filter setting for counting under various condition
- Accumulation, Accumulation display and Accumulation clear functions
- Auto printing within OK range
- RS-232/Relay/Blue Tooth/U-KEY connector/WP wireless print/U-disk Module/Wifi/Ethernet(optional)
- Ideal for applications including production, packaging, shipping and receiving, warehousing, inventory management, in-process parts counting or any other use.



★ White backlight



Model	JCQ-3K	JCQ-6K	JCQ-15K	JCQ-30K
Capacity(kg)	3	6	15	30
Division(g)	0.2	0.5	1	2
Countable unit weight(g)	0.02	0.04	0.1	0.2
Display(mm)	2.5/2.7 digits, 18mm digit height, LCD display			
Weighing units	kg, g, pcs / kg, kg, pcs / g, g, pcs / lb, lb, pcs			
Weighing pan(mm)	280×198 (stainless steel, and 1.0mm in thickness)			
Power supply	AC100~240V / Rechargeable battery (6V/4Ah)			

JCN counting scale



- Resolution up to 1/15,000 (standard) or 1/30,000(optional)
- Single point and linear calibration available
- Unit weight memory up to 20 pieces
- ACAI function results in a more accurate count by increasing the reference weight
- Zero range setting and filter setting for counting under various condition
- Accumulation, Accumulation display and Accumulation clear functions
- Auto printing within OK range
- RS-232/Relay/Blue Tooth/U-KEY connector/WP wireless print/U-disk Module/Wifi/Ethernet(optional)
- Ideal for applications including production, packaging, warehousing, inventory, shipping and receiving areas



Model	JCN-3K	JCN-6K	JCN-15K	JCN-30K
Capacity(kg)	3	6	15	30
Division(g)	0.2/0.1	0.5/0.2	1/0.5	2/1
Countable unit weight(g)	0.02	0.04	0.1	0.2
Display(mm)	6/5/6 digits, 18mm digit height, LCD display			
Weighing units	kg, g, pcs / kg, kg, pcs / g, g, pcs / lb, lb, pcs			
Weighing pan(mm)	294×228 (Stainless Steel, and 1.0mm in thickness)			
Power supply	DC Adaptor 9V, 0.4A/ Rechargeable battery (6V/4 Ah)			

JCO counting scale



- Resolution up to 1/15,000 (standard) or 1/30,000(optional)
- Single point and linear calibration available
- Unit weight memory up to 20 pieces
- ACAI function results in a more accurate count by increasing the reference weight
- Zero range setting and filter setting for counting under various condition
- Accumulation, Accumulation display and Accumulation clear functions
- Auto printing within OK range
- RS-232/RTC/Relay/Blue Tooth/U-KEY connector/WP wireless print/U-disk Module/Wifi/Ethernet(optional)
- Ideal for applications in production, packaging, warehouse, inventory, shipping and receiving areas



Model	JCO-3K	JCO-6K	JCO-15K	JCO-30K
Capacity(kg)	3	6	15	30
Division(g)	0.2/0.1	0.5/0.2	1/0.5	2/1
Countable unit weight(g)	0.02	0.04	0.1	0.2
Display(mm)	6/5/6 digits, 19mm digit height, LCD display			
Weighing units	kg, g, pcs / kg, kg, pcs / g, g, pcs / lb, lb, pcs			
Weighing pan(mm)	310×225 (Stainless Steel, and 1.0mm in thickness)			
Power supply	DC Adaptor 9V, 0.4A/ Rechargeable battery (6V/4Ah)			

JCL counting scale



- Resolution up to 1/15,000 (standard) or 1/30,000(optional)
- A/D covered by aluminium plate, prevent PCB from static and moisture
- Overload and transport protection devices (with anti-cockroach design)
- Zero/ tare/ pre-tare/ zero tracking/ accumulation (99 pieces)/ auto unit weight recomputing/ part counting/ sampling/ check quantity functions
- Auto printing within OK range
- Auto shut off/ auto backlight
- RS-232/RTC/Relay/Blue Tooth/U-KEY connector/WP wireless print/U-disk Module/Wifi/Ethernet(optional)
- Ideal for applications including document distribution, shipping and receiving/ inventory management/ in-process parts counting / prepacking parts/ warehouse or any other use



Model	JCL-1.5K	JCL-3K	JCL-6K	JCL-15K	JCL-30K
Capacity (kg)	1.5	3	6	15	30
Division (g)	0.1/0.05	0.2/0.1	0.5/0.2	1/0.5	2/1
Countable unit weight(g)	0.02	0.02	0.04	0.1	0.2
Weighing units	g / lb / pcs				kg / lb / pcs
Display	6/5/6digits, 19mm digit height, LCD display with green backlight				
Weighing pan(mm)	294×228 (stainless steel)				
Weight	Net weight: 4.48kg, Gross weight: 5.04kg				
Power supply	AC 110V/220V (AC±10%) or Rechargeable battery (6V/4Ah)				

JCE high resolution counting scale

- High resolution in 1/30,000
- Water-resistant durable keypad with anti-cockroach design
- Overload and transport protection devices
- Enhanced software designed for flexible counting operations
- Zero/ tare/ pre-tare/ zero tracking/ accumulation (99 pieces)/ auto power off/ auto unit weight recomputing/ part counting/ sampling/check quantity
- RS-232/RTC/Relay/Blue Tooth/U-KEY connector/WP wireless print/ Wifi/Ethernet(optional)
- Ideal for applications including document distribution, shipping and receiving/ inventory management/ in-process parts counting / prepacking parts/ warehouse or any other use



★ Large stainless steel weighing pan



Model	JCE-3K	JCE-6K	JCE-15K	JCE-30K
Capacity (kg)	3	6	15	30
Division (g)	0.1	0.2	0.5	1
Countable unit weight(g)	0.02	0.04	0.1	0.2
Weighing units	kg / g / lb / pcs			
Display	6/5/5digits, 14mm digit height, green backlight LCD display			
Weighing pan(mm)	334×245 (stainless steel)			
Weight	Net weight: 5.99kg, Gross weight: 6.7kg			
Power supply	AC 110V/220V (AC±10%) or Rechargeable battery(6V/4Ah)			

JCA multifunction counting scale



- High resolution in 1/30,000, OIML approved 1/3,000
- State-of-art identical design with 26 buttons
- Special rugged construction and stainless steel weighing pan
- Overload and transport protection devices
- Zero/ Tare/ Pre-tare/ Auto tare/ Zero tracking/ 50 Preset Unit weight RTC (time display)/ Auto unit weight recomputing/ Part counting/ Sampling/ Check quantity/ Check weighing/ Accumulation (99pieces)/ Serial No./ Max. serial No. performance
- Up to 10 types of printing forms
- Auto printing within OK range
- Optional: removable RS-232 interface x 2, relay interface x 1 and dual channel (connection to larger platforms and floor scales)
- Equipped with Automatic Counting Accuracy Improvement (ACAI)



★ Dual channel
★ Simple recipe weighing function



Model	JCA-3K (NON-OIML)	JCA-6K	JCA-15K	JCA-30K	JCA-60K (NON-OIML)
Capacity (kg)	3	6	15	30	60
Division (g)	0.1	0.2	0.5	1	2
Countable unit weight (g)	0.08	0.16	0.4	0.8	1.6
Weighing units	kg / g / lb / pcs				
Display	6/5/6 digits, 18mm digit height, LCD display with green backlight				
Weighing pan(mm)	320×240 (stainless steel)				
Weight	Net weight: 7.18kg, Gross weight: 7.85kg				
Power supply	AC 110V/220V (AC±10%) or Rechargeable battery (6V/4Ah)				

NWTH weighing scale



- High resolution in 1/20,000
- High impact ABS housing and stainless steel weighing pan
- Bubble level & adjusting feet
- Overload and transport protection devices
- Zero/ Tare/ Weighing/ Simple counting/ Net weight/ Gross weight functions
- Auto shut off for power saving
- Battery life: about 160 hours with backlight on, 260 hours without backlight
- RS-232/U-KEY connector(optional)
- Ideal for family-run shops, factories, schools, offices, household and a wide range of other various weighing applications



Model	NWTH -2K	NWTH -4K	NWTH -6K	NWTH -10K	NWTH -15K	NWTH -20K
Capacity (kg)	2	4	6	10	15	20
Division (g)	0.1	0.2	0.5	0.5	1	1
Weighing units	kg / g / lb / oz / pcs					
Display	5 digits, 19mm digit height, LCD display with green backlight					
Weighing pan(mm)	210×190 (stainless steel)					
Weight	Net weight: 1.4kg, Gross weight: 1.98kg					
Power supply	4°C dry batteries or AC adaptor					

JWQ weighing scale



- Resolution up to 1/15000
- Single point and linear calibration available
- Hold function in peak, stability, or key operation
- Lower/upper limit weighing alarming function
- Zero range setting and filter setting for counting under various condition
- Accumulation, Accumulation display and Accumulation clear functions
- Auto printing within OK range
- RS-232/Relay/Blue Tooth/U-KEY connector/WP wireless print/U-disk Module/ Wifi/Ethernet(optional)
- Ideal for applications in production, packaging, warehouse, inventory, shipping and receiving areas



Model	JWQ-3K	JWQ-6K	JWQ-15K	JWQ-30K
Capacity (kg)	3	6	15	30
Division (g)	0.2	0.5	1	2
Display screen	128X51mm			
Dimension(mm)	275X290X110			
Weighing units	kg, g, t, lb, oz, pcs, 斤 (台斤, 港斤, 市斤)			
Weighing pan(mm)	275x 190(Stainless Steel, and 1.0mm in thickness)			
Power supply	AC 100~240V / Rechargeable battery (6V/4Ah)			

JWN weighing scale

- Resolution up to 1/15,000 (standard) or 1/30,000(optional) or 1/60,000(optional)
- Single point and linear calibration available
- Hold function in peak, stable, or key operation
- Lower/ upper limit weighing alarming function
- Zero range setting and filter setting for weighing under various condition
- Accumulation, Accumulation display and Accumulation clear functions
- Three color change , HI- Red , OK- Green , LO- Orange(optional)
- Auto printing within OK range
- RS-232/RTC/Relay/Blue Tooth/U-KEY connector/WP wireless print/ U-disk Module/Wifi/Ethernet(optional)
- Ideal for applications in production, packaging, warehouse, inventory, shipping and receiving areas



Model	JWN-3K	JWN-6K	JWN-15K	JWN-30K
Capacity(kg)	3	6	15	30
Division(g)	0.2/0.1	0.5/0.2/0.1	0.1/0.5/0.2	2/1/0.5
Display(mm)	30mm digit height, LCD display			
Weighing units	kg, g, t, lb, oz, pcs, 斤(台斤, 港斤, 市斤)			
Weighing pan(mm)	294×228 (Stainless Steel, and 1.0mm in thickness)			
Power supply	DC Adaptor 9V, 0.4A/ Rechargeable battery (6V/4Ah)			

JWO weighing scale

- Resolution up to 1/15,000 (standard) or 1/30,000(optional)
- Single point and linear calibration available
- Hold function in peak, stable, or key operation
- Lower/upper limit weighing alarming function
- Zero range setting and filter setting for weighing under various condition
- Accumulation, Accumulation display and Accumulation clear functions
- Auto printing within OK range
- RS-232/Relay/Blue Tooth/U-KEY connector/WP wireless print/ Wifi/Ethernet(optional)
- Ideal for applications in production, packaging, warehouse, inventory, shipping and receiving areas



Model	JWO-3K	JWO-6K	JWO-15K	JWO-30K
Capacity(kg)	3	6	15	30
Division(g)	0.2/0.1	0.5/0.2	1/0.5	2/1
Display(mm)	25mm digit height, LCD display			
Weighing units	kg, g, t, lb, oz, pcs, 斤(台斤, 港斤, 市斤)			
Weighing pan(mm)	310×225 (Stainless Steel, and 1.0mm in thickness)			
Power supply	DC Adaptor 9V, 0.4A/ Rechargeable battery (6V/4Ah)			

JWRN weighing scale



- Resolution up to 1/15,000 (standard) or 1/30,000(optional) or 1/60,000(optional)
- Single point and linear calibration available
- Hold function in peak, stable, or key operation
- Lower/ upper limit weighing alarming function
- Zero range setting and filter setting for weighing under various condition
- Accumulation, Accumulation display and Accumulation clear functions
- Auto printing within OK range
- RS-232/Relay/Blue Tooth/U-KEY connector/WP wireless print/ U-disk Module/Wifi/Ethernet(optional)
- Ideal for applications in production, packaging, warehouse, inventory, shipping and receiving areas



Model	JWRN-3K	JWRN-6K	JWRN-15K	JWRN-30K
Capacity(kg)	3	6	15	30
Division(g)	0.2/0.1	0.5/0.2/0.1	0.1/0.5/0.2	2/1/0.5
Display	6 digits, 25.4mm digit height, red LED display			
Weighing units	kg, g, t, lb, oz, pcs, 斤(台斤, 港斤, 市斤)			
Weighing pan(mm)	294×228 (Stainless Steel, and 1.0mm in thickness)			
Power supply	DC Adaptor 9V, 0.4A/ Rechargeable battery (6V/4Ah)			

JWL weighing scale



- Resolution up to 1/15,000 (standard) or 1/30,000(optional) or 1/60,000(optional)
- A/D covered by aluminium plate, prevent PCB from static and moisture
- Weighing platter easy to disassemble (with anti-cockroach design)
- Exports the weighing data to PC in the form of EXCEL
- Overload and transport protection devices
- Zero/ Zero tracking/ Tare/ Weighing/ Simple counting / Accumulation/ Check weighing functions
- Auto shut off/ auto backlight
- Auto printing within OK range
- RS-232/RTC/Relay/Blue Tooth/U-KEY connector/WP wireless print/ U-disk Module/Wifi/Ethernet(optional)
- Ideal for factories, incoming/ outgoing goods inspection, inventory management, QC, formulation, general weighing, packaging or other light industrial applications



Model	JWL-1.5K	JWL-3K	JWL-6K	JWL-7.5K	JWL-15K	JWL-30K
Capacity (kg)	1.5	3	6	7.5	15	30
Division (g)	0.1/0.05	0.2/0.1	0.5/0.2/0.1	0.5/0.2/0.2	0.1/0.5/0.2	2/1/0.5
Weighing units	kg/g/lb/pcs/斤/兩					
Display	6 digits, 30mm digit height, LCD display with green backlight					
Weighing pan(mm)	294 × 228 (stainless steel)					
Weight	Net weight: 4.72kg, Gross weight: 5.11kg					
Power supply	AC 110V/220V (AC ± 10%) or Rechargeable battery (6V/4Ah)					

JWE weighing scale



- High resolution in 1/30,000, fast reading
- Water-resistant durable keypad
- Large stainless steel weighing pan (with anti-cockroach design)
- Overload and transport protection devices
- Enhanced software design for flexible weighing operations
- Zero/ Tare/ Weighing/ Percent weighing/ Simple counting / Accumulation/ Check weighing functions
- RS-232/RTC/Relay/Blue Tooth/U-KEY connector/ WP wireless print/Wifi/Ethernet/(optional)
- High standard of accuracy in applications such as pharmaceutical, chemical, electronics, food production, and metallurgy or any other use



Model	JWE-3K	JWE-6K	JWE-15K	JWE-30K
Capacity (kg)	3	6	15	30
Division (g)	0.1	0.2	0.5	1
Weighing units	kg / g / lb / lb.oz / pcs / % / 台斤 / 港斤 / 斤			
Display	6 digits , 25mm digit height, LCD display with green backlight			
Weighing pan(mm)	334×245 (stainless steel)			
Weight	Net weight: 4.72kg, Gross weight: 5.11kg			
Power supply	AC 110V/220V (AC±10%) or Rechargeable battery (6V/4Ah)			

JPL price computing scale



- High impact ABS housing and removable stainless steel pan
- Anti-cockroach design
- Overload and transport protection devices
- Zero/ Tare/ Zero tracking/ Change/ Pricing/ Accumulation (OIML version 25 pieces)/ PLU (10 pieces) functions
- Auto shut off/ auto backlight
- RS-232/RTC/Blue Tooth/U-KEY connector/WP wireless print/ Wifi/Ethernet/(optional)
- Ideal for applications including retail of fruit&vegetables, meats and cheese, delicatessens, confectionery, coffee and tea



Model	JPL-3K	JPL-6K	JPL-15K	JPL-30K
Capacity (kg)	3	6	15	30
Division-1 (g)	0.5	1	2	5
Division-2 (g)	1	2	5	10
Weighing units	kg			
Display	6/5/6 digits, 19mm digit height, LCD display with green backlight			
Weighing pan(mm)	294×228 (stainless steel)			
Weight	With Pole display, Net weight: 5.08kg, Gross weight: 6.49kg		With Rear display, Net weight: 4.48kg, Gross weight: 5.04kg	
Power supply	AC 110V/220V (AC±10%) or Rechargeable battery (6V/4Ah)			

JP2S price computing scale

- Weighing pan , easy disassembly and easy cleaning
- Software filtering function , weighing reaction rate can be allowed to adjust according to different use environment
- Overload protection function
- Change/Pricing/Accumulation(up to 99 pieces and 25 groups of memory function)/Unit Price saved and paged-out functions(up to 10 sets)
- Low power indication and automatic power-off
- Charging or plugging for users to choose , it removes the unstable factors in power or power failure
- Three LCD dual-display windows , and dual-display pole is available
- Zero can be adjusted automatically
- RS-232/RTC/Blue Tooth/U-KEY connector/WP wireless print/Wifi/Ethernet(optional)



Model	JP2S-1530K	
Capacity (kg)	15	30
Division(g)	5	10
Weighing Units	kg/g/pound	
Display(mm)	6 digits, green LED backlight with LCD display(70x25)	
Weighing pan(mm)	294×228×13.5(stainless steel)	
Dimension(mm)	330 x 289 x 104	
Power supply	AC 110V/220V (AC±10%) or Rechargeable battery (6V/4Ah)	

JPT price computing scale

- Easy to operate, and instant display
- Zero, tare, calculate price and change functions
- Show the date and time when the scale standby
- Receipt head and tail information setting, and can check or print the daily report
- 1000 PLU, include the goods name, price and barcode, 60 hotkeys
- Transmit the goods information by PC software with U-disk
- Ideal for applications including retail of fruit&vegetable,meat and cheese, delicatessens, confectionery, coffee and tea

★ With built-in printer

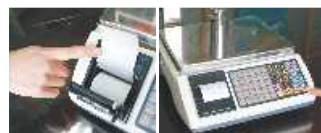

Model	JPT
Weight scope	Max.30 kg , Min.100g
Weighing scope (e)	5 /10g
Port	1×PS/2(barcode scanner), 1×RS-232 (serial port), 1×USB (U-disk), 1×CASHDRAWER
Display	double side LED, 5 digit unit price, 5 digit weight,6 digit total price
Keyboard	25 function keys, 30×2 hot keys
Power supply	Power adaptor input: AC100-240V, 50/60Hz; output: DC7.5V/3Ah
Battery	Rechargeable battery: 6V/4Ah(optional)
Weight	Net Weight: 4.3kg

JWP waterproof scale



- Best 304 stainless steel housing with all sealed PCB design
- Water-proof rubber keypad and complete sealed design with ventilated ring for load cell
- Adjustable feet and level indicator
- Full range tare, parts counting and check weighing functions
- Auto power off timing selection
- Rear display (optional)
- Ideal for applications including high humidity surrounding of food or seafood markets, food processing factories, delicatessens or any other use



★ IP 68 rating certified by SGS



Model	JWP-1.5	JWP-3K	JWP-6K	JWP-15K	JWP-30K
Capacity (kg)	1.5	3	6	15	30
Division (g)	0.2/0.5	0.5/1	1/2	2/5	5/10
Weighing units	kg / g / lb / lb.oz / pcs				
Display	High brightness red LED (6digits)				
Weighing pan(mm)	230×190 (stainless steel)				
Weight	Net weight: 4.72kg, Gross weight: 5.11kg				
Power supply	AC 10V/220V (AC±10%) or Rechargeable battery (6V/4Ah)				

JWI-501 waterproof indicator

★ IP 68 ★ LED display



- All sealed PCB design
- Complete sealed design with ventilated ring for load cell
- Waterproof charger
- Zero/ Tare/ Weighing/ Simple counting/ Check weighing functions
- Auto shut off for power saving
- Ideal for applications including high humidity surrounding of food or seafood markets, food processing factories or any other use



Model	JWI-501
Resolution	15,000 internal graduations
Weighing units	kg / lb / pcs
Display	6 digits, 14.5mm digit height, red backlight LED display
Dimension(mm)	250×163×113
Maximum tare	Full capacity
Accuracy degree	III
Power supply	Rechargeable battery (6V/4.5Ah)

JWI-520 waterproof indicator

★ IP 68 ★ LED display



- Waterproof indicator with grade up to IP68
- Bright LED display
- All sealed PCB design
- Complete sealed design with ventilated ring for load cell
- Waterproof charger
- Zero/Tare /Weighing/Simple counting/Check weighing functions
- Auto shut off for power saving
- RS-232(optional)
- Ideal for applications including high humidity surrounding of food or seafood markets, food processing factories or any other use



Model	JWI-520
Resolution	3000-30000 internal graduations
RS232 interface	Optional
Display	8 digits, 36mm digit height
Dimension(mm)	253.8*85.9*169.5 (without U-shaped support)
Maximum tare	Full capacity
Battery	Rechargeable battery(6V,4.5Ah)
Power supply	5V/2Ah electronic 100~240V/50~60Hz



JWI-688 LED animal weighing indicator

- Up to 1/15,000 resolution
- Attractive outline design with durable stainless steel housing
- Bright LED display
- Adjustable filtering level for weighing under various conditions
- Zero/ Tare/ Weighing/ Simple counting/ Hold/ Net & Gross Weight/ Check weighing function
- Adjustable capacities, resolutions and parameters
- Supports up to 8x350 ohm analog load cell
- Auto shut off/ Auto backlight
- Low battery indication with unique charging lamp
- Ideal for applications in production, packaging, warehouse, inventory, shipping and receiving areas



★ Ideal for weighing animals accurately

Model	JWI-688
Resolution	1/15,000
Weighing units	T, 斤, lb, oz, pcs, kg, g
Display	6 digits, 25.4mm digit height, red LED display
Dimension (mm)	244×150×84
Power supply	AC 110V/220V(AC±10%) / Rechargeable battery (6V/4Ah)

JWI-3000 / 3100 weighing indicator



- ★ 25.4mm Large LED Display
- ★ Window size(mm):165*42
- ★ Ideal for weighing animals accurately

- Up to 1/15,000 resolution
- Attractive outline design with durable ABS housing
- Adjustable filtering level for weighing under various conditions
- Zero/ Tare/ Weighing/ Simple counting/ Hold/ Net&Gross Weight/ Check weighing function
- Exports the weighing data to PC in the form of EXCEL
- Auto shut off/ Auto backlight
- Low battery indication with unique charging lamp
- Auto printing within OK range
- RS-232/Relay/Blue Tooth/U-KEY connector/WP wireless print/ U-disk Module/Wifi/Ethernet(optional)
- Ideal for applications in production, packaging, warehouse, inventory, shipping and receiving areas

Model	JWI-3000	JWI-3100
Resolution	1/15,000	
Weighing units	kg / lb / oz / t / g / pcs / 斤	
Display	6 digits, 34 mm digit height, LCD display with green backlight	6 digits, 25.4 mm digit height, Red LED backlight
Dimension(mm)	221X178X90	
Weight	Net weight: 1.45kg Gross weight: 2.2kg	
Power supply	AC 110V/220V (AC±10%) or Rechargeable battery (6V/4Ah)	

JWI-3000W / JWI-3000C weighing indicator / counting indicator



- Resolution up to 1/15000
- Single point and linear calibration available
- Unit weight memory up to 20 pcs
- ACAI function results in a more accurate count by increasing the reference weight
- Zero range setting and filter setting for counting under various condition
- Accumulation, Accumulation display and Accumulation clear functions
- Auto printing within OK range
- RS-232/Relay/Blue Tooth/U-KEY connector/WP wireless print/U-disk Module/ Wifi/Ethernet(optional)
- Ideal for applications in production, packaging, warehouse, inventory, shipping and receiving areas

Model	JWI-3000W	JWI-3000C
Resolution	1/15,000	
Display	142×46mm, LCD 6 digits	72×30mm, LCD (6 digits, 5 digits, 6 digits)
Housing	ABS	
Weighing units	pcs, 斤, lb, oz, g, kg,	kg kg/ kg g/ g g/ lb lb
Dimension (mm)	222×176×85	
Load cell excitation	DC 5V, Up to 8×350 ohm load cells	
Power supply	DC Adaptor 9V, 0.4Ah/ Rechargeable battery (6V/4Ah)	

JWI-586 weighing indicator



- Up to 1/15,000 resolution
- Bright LCD display with green backlight
- High-impact ABS housing
- Adjustable stand for bench or wall mounting
- Zero/ Tare/ Weighing/ Simple counting/ Percent weighing/ Accumulation / Net/ Gross/ Check weighing functions
- Adjustable filtering level for weighing under various conditions
- Auto shut off for power saving
- RS-232/RTC/Relay/WP wireless print/Blue Tooth/Wifi/Ethernet(optional)
- Ideal for applications in production, packaging, warehouse, inventory, shipping and receiving areas



Model	JWI-586
Resolution	1/15,000
Weighing units	kg / lb / oz / t / g / % / pcs
Display	6 digits, 24mm digit height, green backlit LCD display
Dimension(mm)	280×224×64
Weight	Net weight: 1.8kg, Gross weight: 3.2kg
Power supply	AC 110V/220V (AC±10%) or Rechargeable battery (6V/4Ah)
Load cell excitation	DC 5V, Up to 8x350 ohm load cells

JWI-700W weighing indicator



- 1/30,000 resolution
- High-impact durable ABS housing
- Exports the weighing data to PC in the form of EXCEL
- Adjustable capacities, resolutions and parameters
- Zero/ Tare/ Weighing/ Simple counting/ Hold/ Accumulation/ Net/ Gross / Check weighing functions
- Auto printing within OK range
- RS-232/RTC/Relay/Blue Tooth/U-KEY connector/WP wireless print/ /U-disk Module/Wifi/Ethernet(optional)
- Ideal for applications in production, packaging, warehouse, inventory, shipping and receiving areas or any other use



Model	JWI-700W
Resolution	1/30,000
Weighing units	Kg / lb / 斤 / 兩 / g / oz / pcs
Display	6 digits, 30mm digit height, LCD display with green backlight
Dimension(mm)	274×170×117
Weight	Net weight: 2.52kg, Gross weight: 2.95kg
Power supply	AC 110V/220V (AC±10%) or Rechargeable battery (6V/4Ah)
Load cell excitation	DC 5V, Up to 8x350 ohm load cells

JWI-700B weighing indicator



- ★ 51mm LCD display
- ★ White backlight

- Up to 1/15000 resolution
- Attractive outline design with durable ABS housing
- Bright LCD display with white backlight
- Adjustable filtering level for weighing under various conditions
- Zero / Tare / Weighing / Simple counting / Net & Gross Weight / Check weighing function
- Adjustable capacities, resolutions and parameters
- Supports up to eight 350 ohm analog load cell
- Auto shut off / Auto backlight
- Low battery indication with unique charging lamp
- Auto printing within OK range
- RS-232/RTC/Relay/Blue Tooth/U-KEY connector/WP wireless print / U-disk Module/Wifi/Ethernet(optional)
- Ideal for applications in production, packaging, warehouse, inventory, shipping and receiving areas

Model	JWI-700B
Resolution	Up to 1/15,000
Weighing units	%, t, lb, oz, pcs, kg, 斤, 两
Display	6 digits, 51mm × 19mm of digit size, large LCD display with white backlight
Dimension(mm)	274 × 170 × 117
Power supply	AC 100V~240V or Rechargeable battery (6V/4Ah)

JWI-710 weighing indicator



- ★ 54mm large led display

- Up to 1/15000 resolution
- Attractive outline design with durable ABS housing
- Bright and clear red LED display
- Adjustable filtering level for weighing under various conditions
- Zero / Tare / Weighing / Simple counting / Net & Gross Weight / Check weighing function
- Adjustable capacities, resolutions and parameters
- Supports up to eight 350 ohm analog load cell
- Auto shut off for power saving
- Low battery indication with unique charging lamp
- Auto printing within OK range
- RS-232/RTC/Relay/Blue Tooth/U-KEY connector/WP wireless print / U-disk Module/Wifi/Ethernet(optional)
- Ideal for applications in production, packaging, warehouse, inventory, shipping and receiving areas, especially in harsh and dark environment

Model	JWI-710
Resolution	1/15,000
Weighing units	t, lb, kg, pcs, 斤
Display	6 digits, 54 mm digit height, LED display
Dimension(mm)	274 × 170 × 117
Power supply	AC 100V~240V or Rechargeable battery (6V/4Ah)

JWI-700C counting indicator



- 1/30,000 resolution
- High-impact durable ABS housing
- Exports the weighing data to PC in the form of EXCEL
- Adjustable capacities, resolutions and parameters
- Zero/ Tare/ Weighing/ Part counting/ Sampling/ Check quantity / Accumulation functions
- Auto shut off for power saving
- Auto printing within OK range
- RS-232/RTC/Relay/Blue Tooth/U-KEY connector/WP wireless print/ /U-disk Module/Wifi/Ethernet(optional)
- Ideal for applications including document distribution/ shipping and receiving/ inventory management/ in-process parts counting/ prepacking parts warehouse or any other use

Model	JWI-700C
Resolution	1/30,000
Weighing units	kg / lb
Display	6/5/6 digits, 19mm digit height, LCD display with green backlight
Dimension(mm)	274×170×117
Weight	Net weight: 2.52kg, Gross weight: 2.95kg
Power supply	AC 110V/220V (AC±10%) or Rechargeable battery (6V/4Ah)
Load cell excitation	DC 5V, Up to 8x350 ohm load cells

JWI-700P pricing indicator



- 1/30,000 resolution
- High-impact durable ABS housing
- Adjustable capacities, resolutions and parameters
- Zero/ Tare/ Zero tracking/ Change/ Pricing/ Accumulation/ Price look up functions
- Auto shut off for power saving
- RS-232/RTC/Relay/Wifi/Ethernet(optional)
- Ideal for applications including commercial and industrial needs for the factories, warehouses, quarries, or any other use

Model	JWI-700P
Resolution	1/30,000
Weighing units	kg / lb / oz / 100g
Display	6/5/6 digits, 19mm digit height, LCD display with green backlight
Dimension(mm)	274×170×117
Weight	Net weight: 2.52kg, Gross weight: 2.95kg
Power supply	AC 110V/220V (AC±10%) or Rechargeable battery (6V/4Ah)
Load cell excitation	DC 5V, Up to 8x350 ohm load cells

JIK-4 weighing indicator



- ★ IP 67
- ★ Smaller Size
- ★ LCD Size(mm):125 x 41
- ★ Mechanical keypad

- Waterproof indicator with stainless steel structure
- Standard resolution 1/15000
- Easy to read large display with green backlight
- Zero range can be adjusted automatically, and software filtering function is available, weighing reaction rate can be allowed to adjust under various condition
- Zero/Tare/Net/Gross/Simple counting/Weighing value to save/Check weighing functions
- Single calibration and multiple calibration function is available to ensure the accuracy
- Setting division and capacity to meet different demand
- Supports up to eight 350ohm analog load cell, and also can be well used by matching different sizes scale
- Special charging indicator lamp with low power warning and auto power-off function
- Optional RS232/RTC/Relay/PC/Printer as an external device
- Ideal for production, packaging, warehouse, shipping and receiving areas

Model	JIK-4
Division	1/15000
Weighing units	kg, g, t, lb, oz, pcs, 斤
Display	6digits, 34mm digit height, LCD display with green backlight
Dimension(mm)	200x121x76 (stainless steel)
Power supply	9V/0.4A Adaptor or Rechargeable Battery (6V/2.8Ah)

JIK weighing indicator



JIK-6CAB



JIK-6CSB

- Large LCD display with green backlight
- Both stainless steel and ABS structure are available
- Zero/ Tare/ Weighing/ Simple counting/ Percent weighing / Net/ Gross/ Accumulation/ Serial No./ Check weighing functions
- Auto shut off for power saving
- Auto printing within OK range
- Options: 1×Relay interfaces, 1XRS232 for JIK-6, 2XRS232 for JIK-8, U-KEY connector, Blue Tooth
- JIK indicator is the solution to your weighing indicator applications that require multiple functions, rugged construction, comprehensive yet intuitive software and multiple connectivity options



JIK-8CAB



JIK-8CSB



- ★ Dual Channel
- ★ IP 67

Model	JIK-6 CAB	JIK-6 CSB	JIK-8 CAB	JIK-8 CSB
Housing	ABS	Stainless Steel	ABS	Stainless Steel
Resolution	1/30,000		1/60,000	
Weighing units	kg / g / lb / pcs / %			
Display	6 digits, 30mm digit height, green backlit LCD display			
Dimension(mm)	250×150×90			
Weight	Net weight: 2.5kg, Gross weight: 2.93kg	Net weight: 3.03kg, Gross weight: 3.46kg	Net weight: 2.5kg, Gross weight: 2.93kg	Net weight: 3.03kg, Gross weight: 3.46kg
Power supply	9V/1A adaptor, or 6v/3.2Ah Rechargeable battery			
Load cell excitation	DC 5V, Up to 8x350 ohm load cells			

JIF-8A indicator & controller



- SS cover, simple appearance
- Large LED display, 25mm digit height
- Filter setting for weighing under various condition
- Pre-tare/ Simple counting/Net and Gross Weight switch/Accumulation and accumulation display functions
- Battery and cable in dual mode, auto-off function
- Single point and multi-point calibration available
- Up to 8 * 350Ω L/C and can be used with different sizes of bench scales
- Bring with RS-232/RTC/UART interface, multilevel transmission rate, up to 80 times/sec
- RS-485 interface(modbus) for optional
- Analog output
- Ideal for express, transportation, logistics and other industries

Model	JIF-8A
Input sensitivity	0.12 μ V / d
Input voltage range	-2mv ~ 20mv
Load cell excitation	DC 5V (up to 8*350Ω Load cells)
Non-linearity	0.007% of the total weight, ensure 15000 accuracy
Input impedance	More than 10 x 106 Ω
A/D Conversation	Δ - Σ
A/D Internal resolution	700,000
A/D Conversation Rate	Around 10times/sec
External Display Accuracy	15000
Power supply	AC 230V; Rechargeable battery 6V/2.8Ah

JCWP chicken weighing scale



- Fully stainless steel table scale
- Up to 1/15,000 resolution
- Large LED display and easy to read
- Full digital calibration with auto zero tracking
- Animal lock system with auto hold function
- Low battery indication with unique charging lamp
- Full range tare function and check mode Lo/Hi/OK



Model	JCWP	
Capacity(kg)	30-100kg	60-150kg
Structure(LxWxH)	380x320x360mm	390x340x400mm
Platform (LxWxH)	380x320x55mm	390x340x55mm
Indicator	JWI-688(red LED display)	

JIF-15A weighing controller



- Compact and high efficiency design suitable for any control panels
- Fast 120 times A/D sampling rate perfect for high speed motion batching control
- Internal 24 bits A/D resolution
- Adjustable digital filtering neutralizes vibrations produced at work environment
- Equipped with RS-485 or RS-232 serial interface for remote display, PC, PLC, and HMI
- All function setup and calibration can be done through the keyboard or RS232/RS485 Modbus RTU
- Flexible calibration with 2 standard calibration and 5 linear calibration for higher accuracy
- Flexible Batching modes: insufficient filling, manual and auto discharge, batch loop frequency / weigh / accumulations

Model	JIF-15A
Built-in interface	Rs232 (Modbus RTU and ASCII)
Display	6 weight digits weight; 7 segments 0.56" high red LED
Dimension(mm)	118(L)*96(W)*48(H)
Status indicators	Final, Sp3, Sp2, Sp1, Z, Band, HI/OK/LO, MD(Stable), Zero, Net, Gross
Operation Temp	-10°C-+40°C(+40°F-104°F)
Min. Readability	x1, x2, x5, x10, x20, x50
Loadcell excitation	DC5V±5%, 120mA (up to 8*350Ω Loadcells)
Memory	Calibration parameters and function settings are saved into EEPROM
Input sensitivity	0.12 μV/d and up to 1/60000 d
Max. Measured Voltage	-1mv-39mv
AD Conversation/ Rate	Δ-Σ; 120times/sec

JIF-15B weighing controller



- Industrial grade design for tough industrial environment
- Noise and interference protection. Efficiently block the interference of power and microwave
- Standard equipment: independent RS232 Current Loop and Data Clock Output interface
- 5 stages of linear calibration, providing higher system accuracy
- 24 bits for internal A/D
- Highly stabilized A/D sampling data
- Equipped with self-dialogist function, convenient for on-site maintenance

Model	JIF-15B
Built-in interface	Rs232 & Current Loop and Data Clock Output
Display	7 weight digits weight; 7 segments 0.8" high red LED
Dimension(mm)	148(L)*200(W)*108(H)
Operation Temp	-10°C-+40°C(+40°F-104°F)
Status indicators	3Φ LED, Stable, Zero, Net, Gross, Tart
Min. Readability	x1, x2, x5, x10, x20, x50
Loadcell excitation	DC5V±5%, 120mA (up to 8*350Ω Loadcells)
Memory	Calibration parameters and function settings are saved into EEPROM
Input sensitivity	0.15 μV/d and up to 1/60000 d
Max. Measured Voltage	-1mv-39mv
AD Conversation/ Rate	Δ-Σ; 80times/sec

JIF-15C weighing controller



- Industrial grade design for tough industrial environment
- High precision automatic/dispatch batch controller; equipped with different batching procedures
- Noise and interference protection. Efficiently block the interference of power and microwave
- Dual display panel can display and setting values simultaneously
- All the formula, settings, logic output, function setting and weight calibration can be fine-tuned or calibrated through buttons or RS232/485
- Equipped with RS232/ RS485 serial interface for remote display, PC, PLC, HMI
- Standard edition is equipped with 8 input control connector and 8 relay output connector
- It can save 0-30 codes

Model	JIF-15C
Decimal places	0; 0.0; 0.00; 0.000; 0.0000; 0.00000
Display	7 weight digits weight; 7 segments 0.8" high red LED
Dimension(mm)	148(L)*210(W)*108(H)
Operation Temp	-10°C-+40°C(+40°F-104°F)
Loadcell excitation	DC5V±5%, 120mA (up to 8*350Ω Loadcells)
Memory	Calibration parameters and function settings are saved into EEPROM
Input sensitivity	0.15 μV/d and up to 1/60000 d
Max. Measured Voltage	-1mv-39mv
AD Conversation/ Rate	Δ-Σ; 100times/sec

Iron bench scale

- Removable stainless steel weighing pan
- Non-slip adjustable feet and integral leveling bubbles
- Iron structure for durable performance
- Optional indicators: JIK-8 / JIK-6 / JWI-700B/ JWI-710 /JWI-700W / JWI-700C /JWI-700P/ JWI-586 / JWI-3000 series
- Designed specially with affordability and utility in mind
- Ideal for home office, mail room, shipping and receiving, and general commercial and industrial weighing applications



B-type

A-type

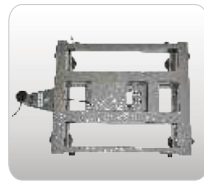

A-type



B-type

Model	Iron bench scale base					
Capacity (kg)	30-100kg	75-150kg	150-300kg	300-600kg	300-600kg	500kg-1t
Platform size(cm)	30×40	40×50	45×60	60×60	60×80	80×80
Load Cell	JL-02	JL-04	JL-03	JL-03	JL-03	JL-03
Pole height(cm)	66					
Pole diameter(cm)	φ3.8					
Structure	Iron					

Aluminum bench scale

- Removable stainless steel weighing pan
- Adjustable feet and integral leveling bubbles
- Aluminium structure ideally suited for years of use in harsh environments
- Durable and reliable
- Optional indicators: JIK-8/ JIK-6/ JWI-700B/ JWI-710/ JWI-700W/ JWI-700C / JWI-700P/ JWI-586/ JWI-520/ JWI-3000 series
- Ideal for shipping and receiving, production, packaging, general commercial and industrial weighing applications



42x52

30x40 & 40x50



Model	Aluminum bench scale base		
Capacity(kg)	75	150	300
Platform size(cm)	30x40	40x50	42x52
Load cell	JL-02	JL-03	JL-03
Pole diameter(cm)	φ3.8		
Pole height(cm)	66		

Stainless Steel waterproof bench scale



A-type

B-type

- Removable stainless steel weighing pan
- Non-slip adjustable feet and integral leveling bubbles
- Stainless steel structure for durable performance
- Optional indicators: JIK-8/ JIK-6/ JWI-700B/ JWI-710/ JWI-700W / JWI-700C/ JWI-700P/ JWI-586/ JWI-520/ JWI-3000 series
- Designed specifically with affordability and utility in mind
- Ideal for home office, mail room, shipping and receiving, and general commercial and industrial weighing applications

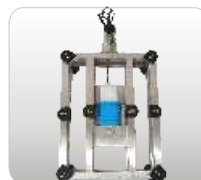

A-type

B-type

Model	Stainless Steel bench scale base					
Capacity (kg)	30-100kg	75-150kg	150-300kg	300-600kg	300-600kg	500kg-1t
Platform size(cm)	30×40	40×50	45×60	60×60	60×80	80×80
Load cell	JL-02	JL-04	JL-03	JL-03	JL-03	JL-03
Pole diameter(cm)	φ3.8					
Pole height(cm)	66					



★ IP 68

Waterproof bench scale

- Plastic covered steel structure with waterproof and corrosion-proof functions
- Bright LED display with red backlight
- Low battery and overload indication
- Auto shut off for power saving
- Display celerity, stable performance and durable
- Ideal for applications including high humidity surrounding of food, seafood, vegetable or any other use



Plastic Covered Steel Structure

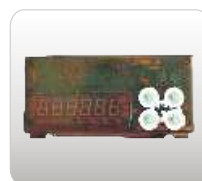

Complete Seal PCB



Ventilated Ring for Load Cell

Model	Waterproof bench scale base	
Capacity(kg)	60	150
Division(g)	10	20
Platform dimension(cm)	30X40	40X50
Pole diameter(cm)	φ 3.8	φ 3.8
Pole height(cm)	42	60
Weighing Units	kg, lb, pcs	
Display	6 digits, 14.5mm digit height, red backlit LED display	
Power Supply	Rechargeable battery (6V/4.5Ah)	
Operating Temp	-5 ~ 40°C	

JPF-2000 floor scale



- High precision load cell
- Heavy duty scale body
- Checker plate or flat plate optional
- Customized size available
- Ramp optional
- Speedy weighing
- Waterproof junction box for the longer service life
- Optional indicators: JIK-8/ JIK-6/JWI-700B/ JWI-710/ JWI-700C / JWI-700P/ JWI-700W/ JWI-586/ JWI-520/ JWI-3000 series
- Ideal for dry weighing needs in industrial and commercial applications

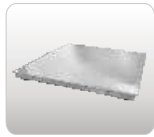

stainless steel type

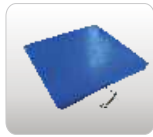

U-shaped steel type

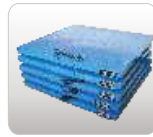

channel steel type

Model	JPF-2000			
Capacity(kg)	0.5t-1t	0.5t-3t	0.5t-3t	1t-5t
Platform size(cm)	80x80	100x100	120x120	150x150
Panel thickness(mm)	5			
Load Cell	JL-05(4 pcs shear beam load cell)			
Material	Stainless Steel/Iron			

JLM pallet truck scale



- With all universal hand pallet truck functions
- Specialized nylon or polyurethane load wheels
- 6 digits LCD display, 30 mm characters height (with backlight)
- Weighing operations: Tare (gross/ net)/ Counting/ Totalizing/ Automatic return to zero
- The battery capacity provides for approx. 25 operating hours
- The system is designed for simple weighing jobs, e.g. calculation of total weights

Model	JLM	
Max. Capacity(kg)	1000	2000
Division(kg)	0.5	1
Lifting height (mm)	75-190	
Fork Size (mm)	Length	1180
	Interior width	340
	Width	180

JC-T crane scale



- Precision aluminum die-casting case
- High strength paint
- Integrated load cell structure
- 18mm LCD display with backlight
- Stainless Steel hook, shackle
- Optional colors



Model	JC-T			
Capacity(kg)	30	60	150	300
Division(kg)	0.01	0.02	0.05	0.1
Weighing units	kg / lb / n			
Display	18mm character height, LCD display with backlight			
Dimension(mm)	265X81X46			
Weight	Net weight 600g; Gross weight 630g			
Power supply	AA*3 dry batteries			
Certification	CE			

JC-M crane scale



- Aluminum die casting alloy with high strength and pleasant appearance
- 360° safe rotated hook and shackle
- IP65 industrial grade to protect from extremely environment
- Built-in long-life environmental lithium-iron battery
- Exclusive patent load cell, better than 1/3000 division



Model	JC-M					
Capacity(kg)	30	50	100	150	200	300
Division(kg)	0.01/0.005	0.02/0.01	0.05/0.02		0.1/0.05	
Net Weight(kg)	1.5					
Display	Red backlit LED display or LCD display					
Others	Time to Stable Reading: ≤ 8s			Maximum Safe Load: 125 % F.S.		
	Limited Overload: 400% F.S.			Overload Alarm: 100% F.S. +9e		

JC II crane scale



- Aluminum die casting alloy with high strength and pleasant appearance
- Super bright 5 digit red LED display with 40mm height
- Infrared control with Peak Hold, Tare, Zero, Total Function
- Optimized design, wireless palm indicator optional after upgrading



Model	JC II					
Capacity(kg)	1000	2000	3000	5000	10000	15000
Division(kg)	0.5/0.002	1/0.5	1/0.5	2/1	5/2	10/5
LxWxH(mm)	119x163x466		198x163x573	198x163x579	210x180x622	220x190x753
Display	5 digit, 40mm height, Red LED display					
Others	Time to Stable Reading: ≤ 8s			Maximum Safe Load: 125 % F.S.		
	Limited Overload: 400% F.S.			Overload Alarm: 100% F.S. +9e		

JC crane scale

- 360° Freely swiveling hook; Easy to operate
- Large and bright red LED with wide view angle
- Aluminum housing with corrosion-proof and antistatic functions
- Units: kg/ lb
- Auto-zero/ Tracking zero/ Weighing function
- Auto shut off for power saving
- Wireless controller as a standard
- Economical solution for many simple weighing needs



For cap.600kg-15t

For cap.20t-30t

Model	JC									
Capacity (kg)	600	1000	2000	3000	5000	10000	15000	20000	30000	
Division (kg)	0.2	0.5	1	1	2	5	5	10	10	
Net weight (kg)	13.0	13.0	13.0	14.0	24.0	35.0	55.0	75.0	152.0	
Display	5 digits, 30mm character height, red backlit LED display or 5 digits, 40mm character height backlit LCD display									
Power supply	6V10Ah Rechargeable battery									
Battery life	150 hours (8 hours charging time)									

Wireless crane scale



JCW-B

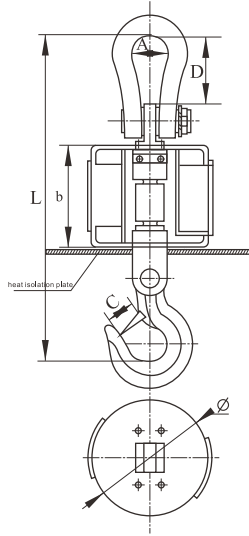

- Impact resistant all steel construction for RFI protection
- Patented LN high precision crane scale load cell
- Optional operation temperature normal(-15°C~55°C), or thermal(~80°C) environment
- 6V/4Ah Ni-H rechargeable battery for the scale

Type	1t	2t	3t	5t	10t	15t	20t	30t	40t	50t
Division(kg)	0.5	1	1	2	5	5	10	10	20	20
A	76	76	75	75	106	150	150	150	214	214
B	105	105	140	195	195	220	220	220	300	300
C	34	34	40	56	70	86	86	103	105	105
D	95	95	95	92	117	118	118	172	274	274
L	460	460	500	620	712	897	897	1050	1263	1263
Ø	190	190	240	270	270	295	295	320	375	375



JCW-K

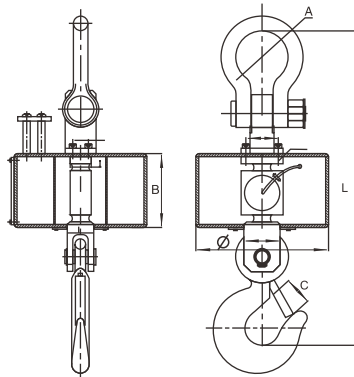

- Newly designed K series scale, sturdy and portable
- Impact resistant all steel construction for RFI protection
- Long-life environmental LFP battery for scale

Type	1t	2t	3t	5t	10t	15t	20t
Division(kg)	0.5	1	1	2	5	5	10
A	76	76	76	80	90	135	150
B	125	125	125	125	130	141	148
C	40	40	40	50	54	60	73
Ø	240	240	240	240	263	263	295
L	467	467	467	536	610	729	811
N.W.(kg)	15	15	15	23	36	52	65



JCW-M

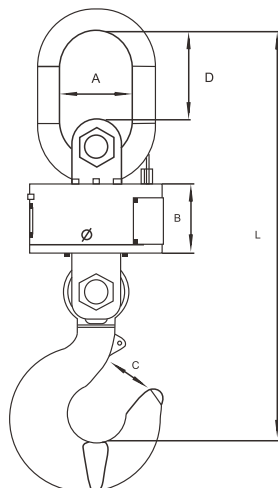

- Dual load cell specially for large capacity crane scale
- Excellent performance, high security and cost performance
- Double shackle or shackle/hook for choice
- Round steel housing, shock-resistance and anti EMI
- Optional wireless indicator C, hand-held indicator P II and scoreboard display

Type	32t	50t	80t	100t
Division(kg)	10	20	50	50
A	180	190	240	250
B	158	210	245	245
C	103	105	155	155
D	272	285	292	311
Ø	300	350	453	453
L	1061	1114	1411	1441

Optional indicators for wireless crane scale



C Indicator

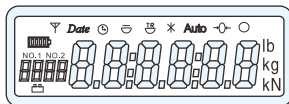

LCD Display

- Built-in wharf crane scale auto-weighing accumulating procedure
- Memory store up to 2900 weight data set
- Easy repair with interchangeable and compatible design
- Open procedure for adjustment and setting under different working environment
- Using RS232 interface to connect the computer
- Optional 4-20mA remote transmission module



Battery



Totalising



Wireless



Micprint

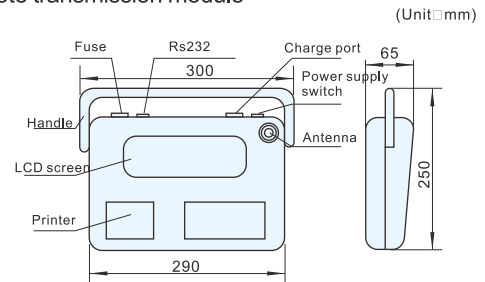

(Unit:mm)



C II Indicator

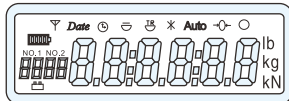

LCD Display

- Built-in thermal microprinter
- Memory store up to 2800 weight data set
- High definition FSTN display
- With RS232, and RS485 optional
- Built-in 6V/4.5Ah LFP battery



Battery



Totalising



Wireless



Micprint

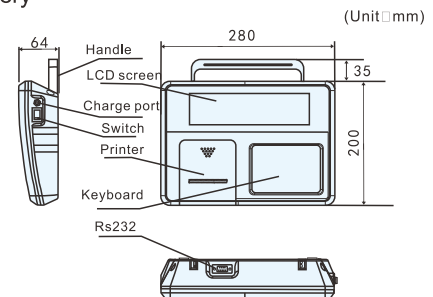

(Unit:mm)



P II Indicator



Battery



Wireless



Display

- Smart hand-held wireless indicator with 32 optional frequency points
- OLED dot matrix display makes customized interface on boot-up available
- Broad range of working temperature, no delay in displaying the weighing data under low temperature
- Unique frequency sweeping function, supporting fast match and indicator mutual exchanging
- Perform as the weighing indicator or dynamometer by receiving the data transmitted from the A/D converter

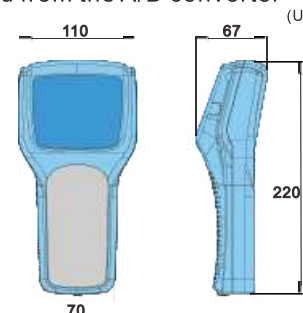

(Unit:mm)

Accessories



Godex Thermal Printer



GP Barcode Printer



Dot Matrix Printer



Printing Paper



Barcode Scanner



Lead-acid Battery



Iron Weights



U-KEY & Computer cable



RS232&RTC&RELAY(JIK-CAB)



RS232&RTC&RELAY(JIK-CSB)



RS232&RTC&RELAY



Large LED Display



Light Tower



Waterproof Junction Box

Stainless steel



Stainless Steel Weights



JL-01
(for table scale)



JL-02
(for bench scale)



JL-03
(for bench scale)



JL-04
(for bench scale)



JL-05
(for floor scale)



JL-06
(for truck scale)

Model	JL-01	JL-02	JL-03	JL-04	JL-05	JL-06
Material	Aluminum			Alloy steel		

Floor scale kit

Floor scale kit, with the JL-05 load cell and waterproof junction box JOB-84, is the best solution for your 0.25~10ton floorscale.

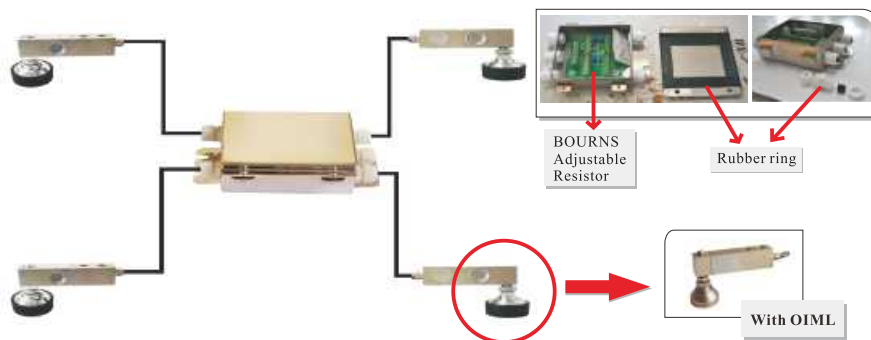

JP-01 label edit print module

- Break the traditional e-scale label tags, edit label freely by APP, switch the different material freely
- Switch multiple labels randomly, easy to operate
- Transfer data by Blue Tooth, one-click download, edit and save simultaneously and immediately



U-disk connection module

- Converts weighing data to excel file stored in U-disk
- Weighing data including serial number, date, time
- Auto store within ok range

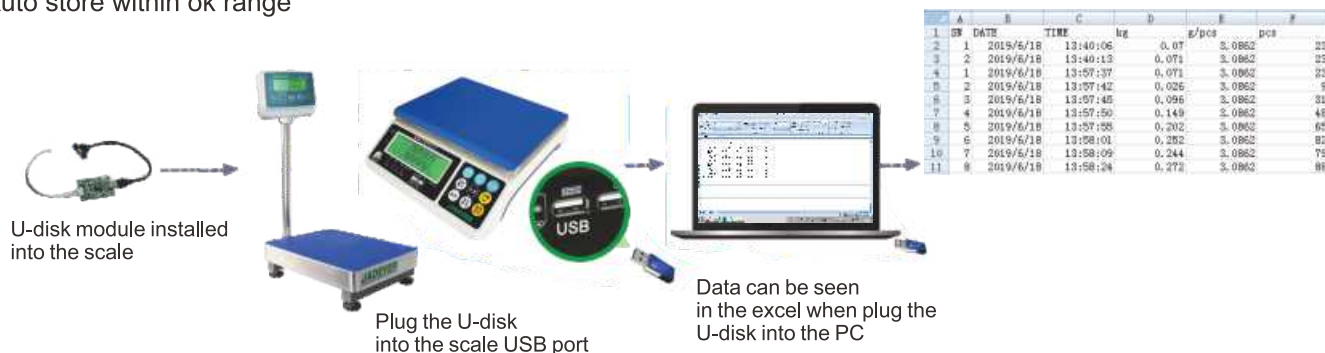

Bluetooth modules (one to one connection)

Four Modes of Connection

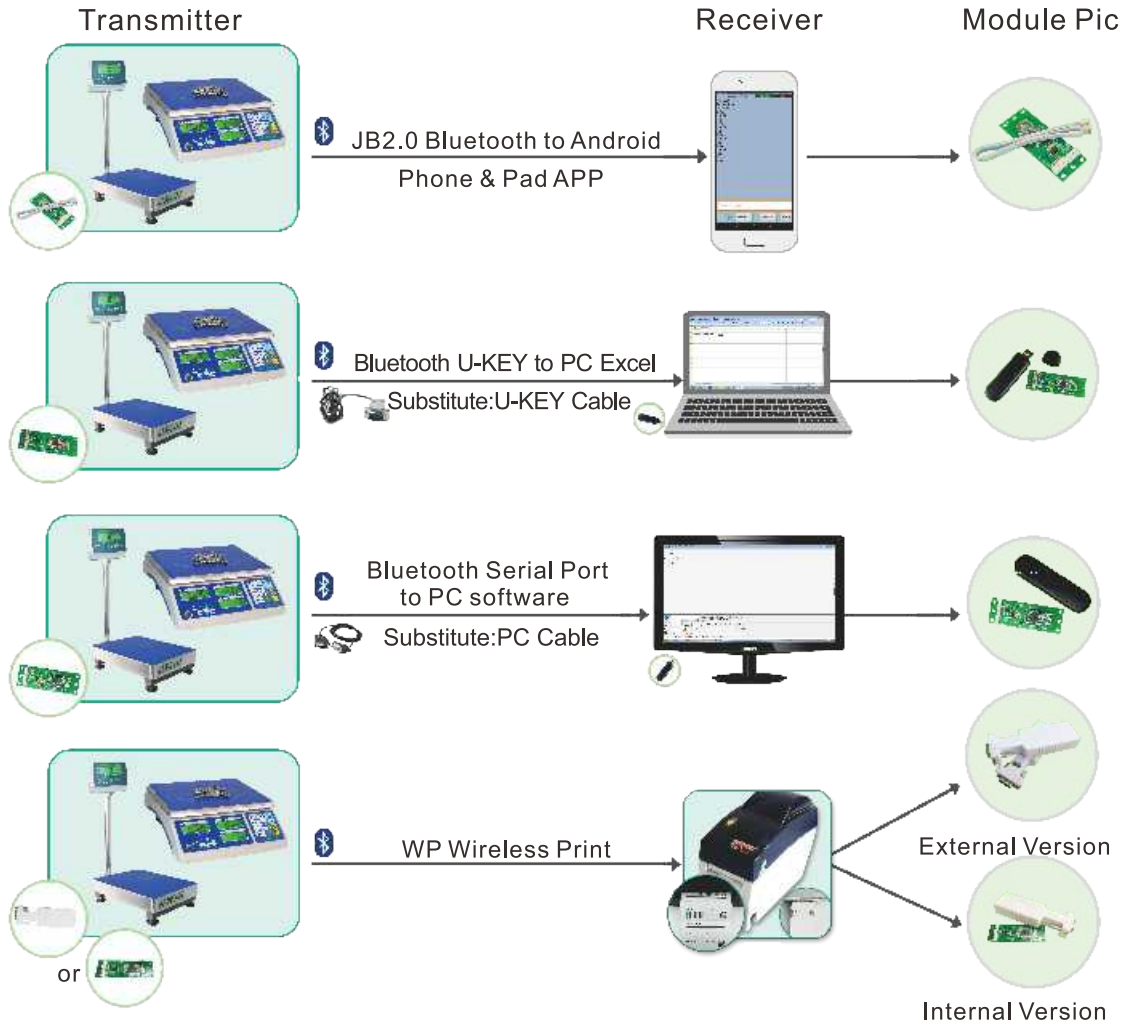

Wifi & Ethernet modules (one to multiple connection)

- Can transmit the weighing data to various devices simultaneously
- Two way communication

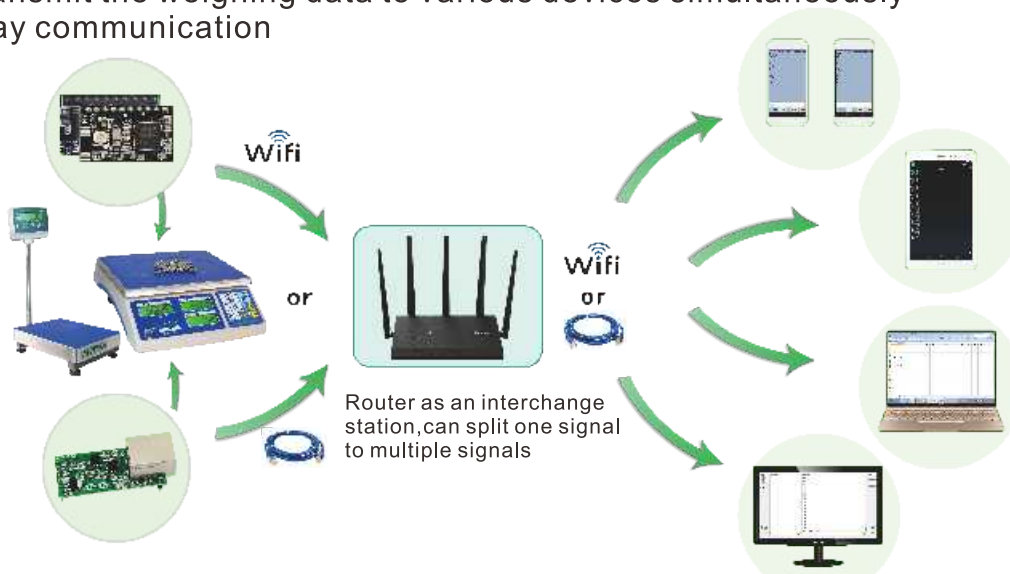

JDI-800 Intelligent Indicator



Can connect with ERP



Achieve paperless data

Using background :

- This is an example of our customer which it is a corporation of developing petroleum additives
- Our JDI indicators help them to assure a better and more accurate dosing with different materials
- It serves as recipe system, but more intelligent and more functional

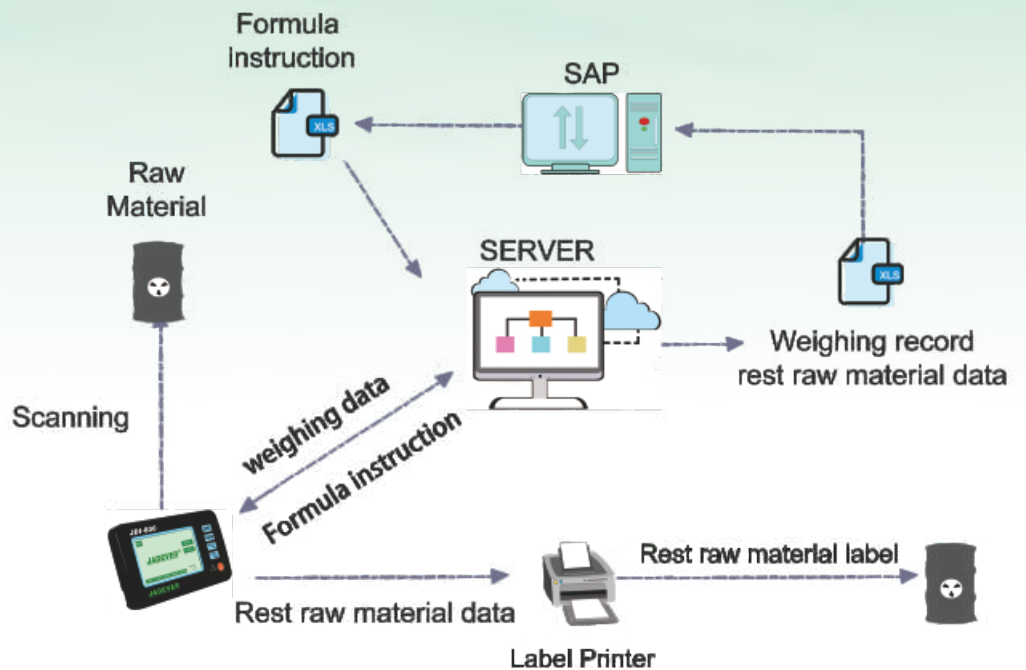

For More Information

JADEVER was founded in July, 1986. During its first years of existence, the company advanced in technology innovation and developing a business plan. In 1998, the company achieved its main quality goal, when the first of their products received approval from the International Organization of Legal Metrology. In 1999, Xiamen Jadever Scale Co., Ltd. was established; the main production area for the company is located here. By the year 2006 Jadever acquired ISO 9001:2000 certification.

Currently, the company maintains its headquarters in Taipei, plus branches in seven cities, (Shanghai, Shenzhen, Wuhan, Tianjin, Qingdao,) and an international branch in Markham, Canada.

Jadever follows a policy of four pillars: discipline, honesty, knowledge and innovation. Enclosed to its pillars, the company pursues three main goals:

In broad terms, the company's project is to maintain and strengthen its world-renowned position as a trustful brand on the market it competes.

Main goal:

- Persistence in quality
- Responsibility for cost
- Challenge against perfection



Taiwan Headquarters

Taiwan Headquarters

Jadever Scale Co., Ltd.
Add: 8F, No.11 Wu-Chuan 1 Rd, Sinjhuang District, New Taipei City, Taiwan 248
Tel : +886-2-22990203
Fax: +886-2-22990204
http: www.jadever.com
E-mail: sales@jadever.com.tw

Canada

Jadever Weighttech, Inc.
Add: 16 Lady Veronica Lane, Vaughan, Ontario L6A 0G1
Tel : (905)482-2618
Fax: (905)887-4066
E-mail: james@jadeverscale.com

China

China

Xiamen Jadever Scale Co., Ltd.
Add: 7F, No.40 Huli Avenue, Huli District, Xiamen 361006, Fujian, China
Tel : +86-592-6037668
Fax: +86-592-6037028
http://www.jadever.com
E-mail: christinelu@jadever.com.cn
xmjadever@jadever.com.cn



Website